



CD-16 CHRONOMETER with BCD OUTPUTS.

The CD-16 module allows standard functions of a chronometer as "Start / Stop, Lapso / Reset", count up and count down, etc., with BCD data output. It accepts automatic count up / down and chronometer. It could control CD-10, and CD-41 Cebek displays. It includes protection against inversion polarity. Leds and acoustic indicators as well as connection terminals.

TECHNICAL CHARACTERISTICS.

Voltage	12 V. D.C.
Minimum Consumption	10 mA.
Maximum Consumption	60 mA.
Chronometer time on Sade Nº1	From 0 till 99minutes.
Chronometer Time on Scale Nº2	From 0 sec. till 99 hours.
Signal level of BCD outputs	Voltage.
Maximum output load	5 A.
Protection against inversion polarity, (P.I.P.)	Yes.
Sizes	96 x 95 x 30 mm.

POWER SUPPLY AND INSTALLATION.

POWER SUPPLY. The CD-16 circuit had to be supplied by a 12 VDC power supply correctly filtered. We recommend you to use the FE-2power supply which has been developed to perfectly answer to the circuit needs. Install a fuse and a switch as it is indicated on the schedule. Both are necessary for the module's protection as well as for your own safety, as it is required by the "CE" regulations. Connect the positive and the negative of the power supply to the respective positive and negative terminals of the module, indicated in the wiring map. The distance between the power supply and the module has to be as short as possible. Verify that the assembly is correct.

Note. Connections indicated as 230 VAC in the wiring map have to be connected to 110 VAC, in American countries. Cebek's Modules and/or transformers will be supplied with corresponding modifications for their connection in these countries.

CONNECTION BETWEEN BCD OF THE CD-16 and BCD OF DISPLAYS.

In order to visualise operations and data of the chronometer, you have to use displays with BCD inputs. With Cebek range you could find out several modules with BCD inputs composed by a single display (like CD-10 and CD-11) or by 4 display like the CD-41. All are completely compatible with the CD-16 module.

The CD-16 module offers 4 BCD inputs: Units, tens, hundreds, thousands. Each input had to be connected to the corresponding display. If you don't proceed as mentioned, the digit displayed could be correctly read.

Each BCD output, itself, is composed by 4 data terminals: A, B, C and D. You have to connect each terminal to its corresponding terminal on the display. The A terminal of the CD-16 units has to be connected with the A terminal of the display units; the B terminal of the CD-16 tens has to be connected with the B terminal of the display tens, and proceed like this with all terminals. Be careful on the assembly to be sure to correctly connect terminals A with A, B with B, etc... See fig. 1. Then you will avoid any malfunction of the module.

If you don't use the same power supply for the CD-16 and Displays, you have to inter-connect their respective power supplies as well as negative terminals of the module and displays. If you use the same power supply, to supply all modules, you don't need this connection.

Fig. 1. How to connect BCD outputs of CD-16 units and BCD input of a Cebek Display units, in this case the CD-10.

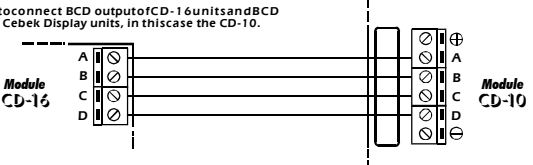

OUTPUT CONNECTION. LOAD. The CD-16 output is controlled by a relay, and accept any device up to 5 A. The relay is not a component supplying voltage but its function is limited to accept or deny the voltage passage like a standard switch. For this reason, you have to supply the load through this component.

The relay has three output terminals: the normally open quiescent (NO), the normally closed quiescent (NC) and the common. Install it between the Common and the NO in accordance with the schedule "Output Connection. Load". For the inverse function you have to place the load between the NC and Common.

HOW TO CONNECT THE RELAY. The module relay output allows two operating modes. If you close the Jp1 jumper, the relay will be activated and maintained in this state when you don't use the chronometer. At the opposite, and maintained in this state only when you use the chronometer. See the Fig. 2.

If you leave open the Jp1 jumper, (as it is originally supplied), the relay will be activated and maintained in this state only when you use the chronometer. See the Fig. 2.

Fig. 2. Configuration of the Jp1 jumper. Relay connection mode.

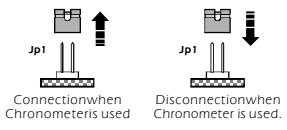

OPERATING MODE.

DO NOT FORGET. In several paragraphs of this instruction manual, it will be required to simultaneously press two buttons. The process that you have to follow to correctly do this operation, and to not confuse the module, is: Firstly you have to press on the first indicated button and then, maintaining this button pressed, you have to push the second indicated button. Once confirmed the order, you could stop to press both buttons.

To program the memory, to select the scale or other special operations allowed by the circuit don't could be used at the same time than chronometer function. Before you have to stop and reset the chronometer.

ABOUT THE MODULE. Each time you communicate an order to the CD-16, the State Led will quickly light and the acoustic indicator will emit a sound which could change according to the operation done. More over, and to confirm that a button has been correctly pressed, when it is correctly done, the acoustic indicator will emit a short "bip" to confirm.

The relay Led will light when the relay is activated. The rest of Leds will light according to the operation done, as it is indicated on the corresponding paragraph.

TIME SCALES. Once the module installation done, you could use it. Firstly you have to indicate the time scale. The minimum time to use the chronometer function is 0 sec. Nevertheless, as maximum time the CD-16 will offer two possibilities or two scale. The scale Nº1 allows a maximum time of 99 minutes and the scale Nº2 offers a maximum time of 99 hours. Originally the module is supplied with the scale Nº1.

To select the scale Nº2, you have to press at the same time "#" and "8". If the operation has been correctly done, the Time Led will light.

To select the scale Nº1, you have to press at the same time "#" and "7". If the operation has been correctly done, the Time Led will be extinguished.

Fig. 3. To select Timescale.

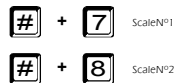

MANUAL / AUTOMATIC CHRONOMETER FUNCTION. The CD-16 could be used on manual or automatic mode. The manual mode correspond to the normal operating mode of a chronometer with the beginning at zero and the end when you press "Stop". The automatic mode allows to program a time digit on the memory. From this digit you could start the chronometer function in count down and automatically stop when it reaches zero or a count up with an automatic stop when the programmed digit is reached.

To select an operating mode you have to proceed as following. If you program in memory any digit different of "0000", the CD-16 will operate on automatic mode with mentioned digit. At the opposite, you insert in memory "0000", the CD-16 will operate in manual mode.

To insert a digit in memory, you have to simultaneously press "#" and "3", immediately state and Chrono Leds will intermittently light to indicate that the program function is activated. Then, you have to introduce the wished digit. Each inserted digit will be indicated on the right side display, moving the others one position to the left side. When the display indicate the wished complete digit, press the confirmation button, "*".

To reset the memory, you have to repeat the program process, recording the digit "0000". Each time you insert in the memory a new digit, to replace the previous one, it will be maintained into the memory even if you stop to supply the module.

OPERATING MODE.

If the inserted digit is incorrect, and stored in memory, the module will confirm the operation with a continuous sound and lighting complete and momentarily Chrono and State Leds. If the digit is incorrect, the circuit will emit three acoustic sound and Chrono Led will intermittently light. Then, the program function will be abandoned without recording any digit. For instance, a wrong digit to memorise could be 10 min. 69sec., because the correct digit is 11 min. 9 sec.

Note. The recorded digit in memory will correspond to minutes and seconds if you have selected the scale Nº1, and hours and minutes if you have selected the scale Nº2. press at the same time "#" and "4", this one will intermittently appear on display during 5 sec. with an acoustic signal similar than a radio hour signal.

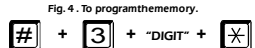

Fig. 4. To program the memory.

TO VISUALISE MEMORY. If you don't remember the recorded digit or if you simply wish to see this digit, you have to press at the same time "#" and "4", this one will intermittently appear on display during 5 sec. with an acoustic signal similar than a radio hour signal.

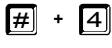

Fig. 5. To visualise the memory.

CHRONOMETER UP/DOWN. You could configure the CD-16 to chronometer a count up or a count down. If you press at the same time "#" and "1" buttons, the Up/Down Led will light to indicate that you have selected to count up. At the opposite, if you press at the same time "#" and "2" buttons, Up/Down Led will be extinguished to indicate that you have selected to count down.

With the count up, the chronometer function will start from zero. If you have programmed a digit in memory, the chronometer function will be stopped when the digit is reached. If you don't have programmed any digit, when the chronometer reach the maximum digit (99.59), it will start again from zero.

With the count down, the chronometer could only be used if you have previously programmed in memory a digit. Then, the chronometer will start the count down from this digit and stop when it reaches the zero. start the count down from this digit and stop when it reaches the zero.

Fig. 6. Count Up/Down with Chronometer.

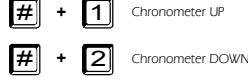

CHRONOMETER. The basic functions of a chronometer as Start, Stop, Lapso or reset, are done as with watch. See Fig. 7, where the function of each button is described.

Start/Stop. To use the chronometer function, firstly you have to press the Start/stop function. To stop it you have to press again on this button. The Chrono Led will light when the chronometer function is used.

Fig. 7. To assign Chronometer functions



Reset. When you stop the chronometer, the result will be visualised on the display. If you wish to erase this result, to place the chronometer at zero, you have to reset it pressing the Lapso/Reset button.

Lapso. When the chronometer function is activated, before to press the Stop button, if you press the Lapso/Reset button, you will do a break allowing to read this time result, without internally stop the chronometer. When the "Lapso" function is activated, the Chrono Led intermittently light. To leave this function and go back to the internal count, you have to press again on the Lapso/Reset button.

If during the "Lapso" function you press the Start/Stop button, you will stop the chronometer's internal count. Then, when you press again the Lapso/Reset button, it will be displayed the internal record where you have stopped it, awaiting to a reset. (pressing again on the Lapso/Reset button).

IMPORTANT. Do not modify, amplify or remove the connection cable between keyboard and CD-16 board. If you don't respect this point, the module doesn't properly work and the warranty will be automatically cancelled.

GENERAL WIRING MAP.

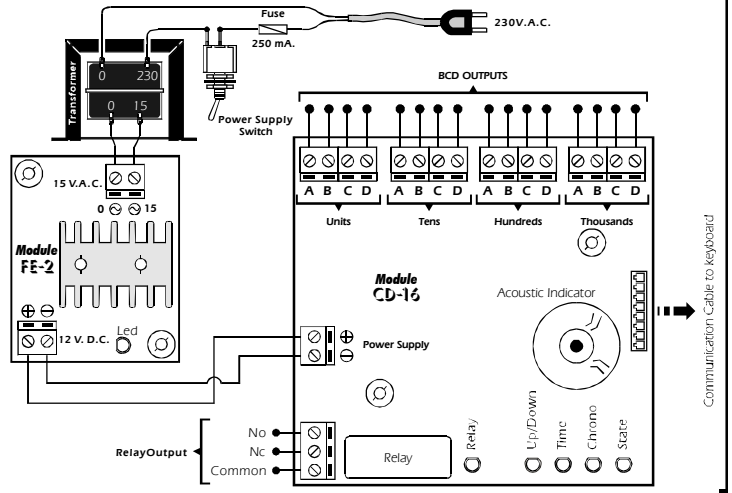

OUTPUT CONNECTION. LOAD.

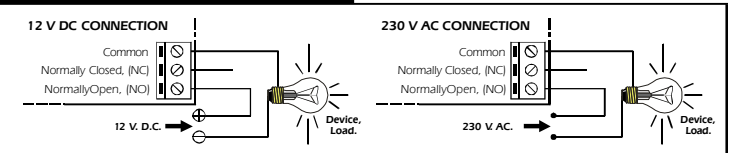

INFORMATION ABOUT THE OUTPUT. During the operating mode and according to its load, it could happen a fluctuation or an incorrect working of the output. In such case, you have to install an anti-spark circuit between both contacts of the used relay, as it is indicated on the schedule.

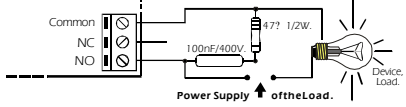

TECHNICAL CONSULTATIONS.

If you have any doubt, you could contact your wholesaler or our Technical Department. - E-Mail, sat@cebek.com | Fax. 34.93.432.29.95 | by mail. P.O. Box. 23455 - 08080 Barcelona - Spain. - Keep the invoice of this module. For any repair, the corresponding invoice had to be added. If the invoice is not presented together with this module, the module's warranty will be automatically cancelled.

All the module's CEBEK have 3 years of total warranty in technical repairing, and spares from the date of buy.



More CEBEK modules are available in our products range, please, require our general catalogue or visit our Website. <http://www.cebek.com>

