



DA-02

ACCESS CONTROL TILL 1999 MAGNETIC CARDS.

The DA-02 is an access control for magnetic cards with 1999 card as maximum. It includes local controls to authorize, deny, consult and "setup" cards. It allows to change serial numbers to use several controllers on a same place. It has relay outputs with possibility to configure timing between 1 and 4 sec.

TECHNICAL CHARACTERISTICS.

Volatge.	12 V. DC.
Minium Consumption.	30 mA.
Maximum Consumption.	100 mA.
Relay Timing.	From 1 up to 4 sec.
Maximum Load to relay.	4 A.
Maximum Storage Capability	1999 Cards.
Minimum Speed to insert card.	10 cm/sec.
Maximum Speed to insert card.	150 cm/sec.
Maximum Duration of the players' head.	500,000 Readings.
Sizes of the PCB.	96 x 67 x 30 mm.
Sizes of pre-selectors.	72 x 45 x 40 mm.

OPERATING.

POWER SUPPLY. The DA-02 circuit had to be supplied by a 12 VDC power supply correctly filtered. We recommended you the FE-2 power supply which has been developed to perfectly answer to the circuit needs. Install a fuse and a switch has it i sindicated on the schedule. Both are necessary for the module's protection as well as for your own safety, as it is required by teh "CE" regulations. Connect the positive of the power supply to the positive terminal indicated in the wiring map, then connect the negative of the power supply to the negative terminal indicated in the circuit. **Verify that the assembly is correct.**

OPERATING. The module operating could be divided according two parts (or concepts): **Operations control** and its use in **common work**.

READINGS CARDS OPERATION. Before to explain the operations control or its use in standard way, you have to correctly insert cards on the reader. This operation is basic and very important for any operating modes. First of all you have to see the drawing which show a typical card of the DA-02 module and its reader. The drawing show how to insert the card on the reader . The part with the magnetic band have to be placed on the reader side (with the arrow) and at the interior.

When you have placed the card on the reader, you have to go down at normal speed to allow the reading of the magnetic band. If you correctly proceed, the reader could read the card and accept all necessary operations.

OPERATIONS CONTROL. The operations control of the DA-02 is composed by 4 micro-switches allowing to authorize, deny, check cards. These micro-switches will be used to configure the module before to leave it as standard access control. The 4 switches composing the operations control are indicated as Check, Charge, DisCharge and Serial.

Serial Authorization. The first operation that you have to done is the serial authorization. Potentially, there were several users with DA-02 modules and all with cards from 1 up to 1999 similar than you.

Theoretically, any people without relation with your DA-02 module but with a Cebek card and an authorized number could accede. For this reason, each DA-02 module is supplied with a card pack incorporating an internal and exclusive code which allow to difference all DA-02 modules.

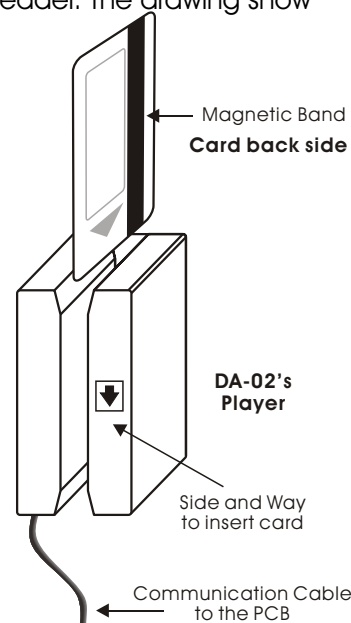



OPERATING.

This "serial number" had to be authorized on the reader to allow the circuit to accept the other operations as authorization, deny, check, etc... Then the module only recognise cards with this code, denying other cards. Supply the module, and to activate the serial number operation you have to place the switch N°4 in ON position. All other switches have to be in OFF position. The "serial" Led will light indicating you that you have selected the "Serial number" operation. Using one of the 5 cards that you have received with the module, insert it on the reader. Then the reader will read the serial number. If you have correctly proceed, the green Led will light on and you listen to an acoustic signal.

If you do not heard the signal and green Led doesn't light, it means that you have probably wrongly insert the card. Insert again the card.

When you have correctly inserted the card, the green Led will light awaiting to receive the "Serial number" confirmation. Insert again the card on the reader, then the acoustic signal will be different and green Led will permanently light on.

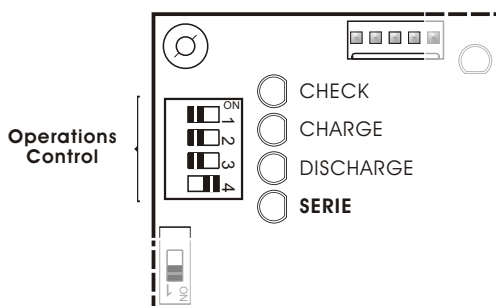

Therefore, the serial number will be recorded on the circuit even if you disconnect the power supply, and the module will be configured to be exclusively used with your cards.

When you have finished this operation, you have to place again the switch N°4 in OFF position.

Cards Authorization. After establishing the serial number, you have to authorize each card. In the previous operation you have configured the reader to only operate with your cards ; now you have to inform it which are authorized.

Then, you have to place the switch N°2 in ON position. Verify that other switches are in OFF position. The led indicated as "Charge" will light to indicate that you have selected the "Authorization" operation.

Do never select more than one switch for each operation to avoid to damage the module.

As for the "Serial number" operation, you have to insert two time the card on the reader. The first insertion, the green led will light on and you could heard a short acoustic signal. The second one confirm you the operation with a long acoustic signal and green Led will light on some instants. If the operation proceed as we have described you, then the card is authorized.

Then, to authorise other cards you have to proceed as previously. Between two authorization, you have to wait

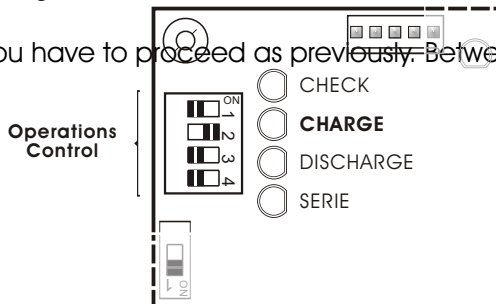

that the Led light off.



DA-02

ACCESS CONTROL TILL 1999 MAGNETIC CARDS.

OPERATING.

Cards Deny. When you use the DA-02 module, it is necessary to deny some cards previously authorized. As you do not have all the time the possibility to recuperate the card to cancel it, the DA-02 module could deny card even if you do not have in your possession this card.

As for other operations, firstly you have to select the "Deny card" according to the operations control. Place the switch N

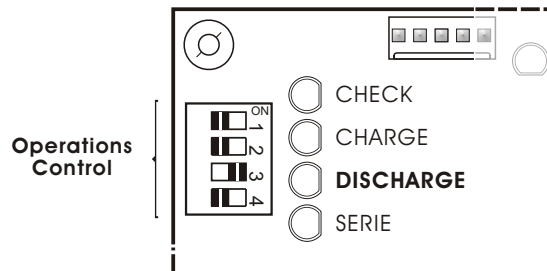

3 in ON position and verify that other switches are in OFF position. The Discharge Led will light on.

According to the General Wiring map, you could see that together with the main module with the Enter button, you have have an other PCB with 4 pre-selectors, one for each digit (unit, ten, hundred, thousand). Thanks to these pre-selectors and the Enter push button you could deny a card.

Then, you have to insert the number of the card to deny on the PCB with pre-selectors, respecting unit, ten, hundred & thousand order. Once selection is done, press the Enter button (on the main PCB). There will have an acoustic signal and the OFF red Led will light for a short moment, indicating that this card had been denied. To deny other cards, you have to proceed as previously and wait that the Led light off. On the drawing and as

FRONTAL VUE OF THE PRE-SELECTROS PCB
How to select the card n° 421.

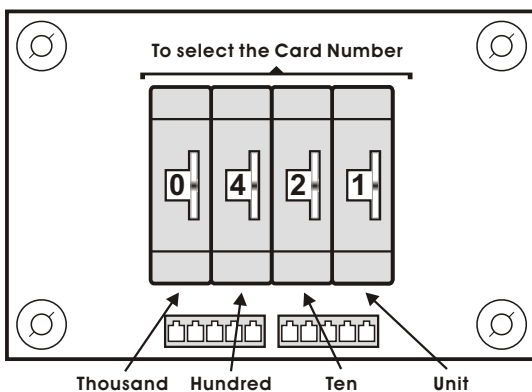

FRONTAL VUE OF THE PRE-SELECTROS PCB
How to select the card n° 1379.

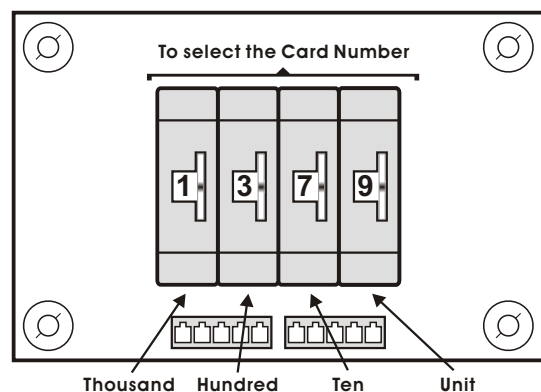

sample, you could see how to select cards N° 421 and 1379.

Verification - Checking of cards situation. Es muy probable, que it is possible that in some weeks, using continuously the DA-02 module (Authorizing and Denying cards) you do not remember which card is authorized and which one is denied. For this reason, the module includes a verification function. Thanks to this operation, you could check without the card if it is authorised or denied.



OPERATING.

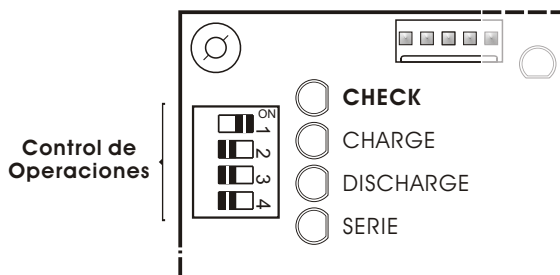

Select the function "Check" on the operation control. Place the switch nº1 in ON position and verify that other switches are in OFF position. Then the Check led will light on.

As in the deny function, you have to select the card number on Ten and Units switches packs. Then, you have to press the Enter push button. If the acrd is authorised, the green led ON will shortly light on and you heard an acoustic

OPERATING.

COMMON WORK FUNCTION. Once all operations (authorization, deny, serial, etc...) are done, you only have to place the DA-02 module where you wish to control the access and start its operating in common work. In this state, the module have to have all switches of the operations control in OFF position.

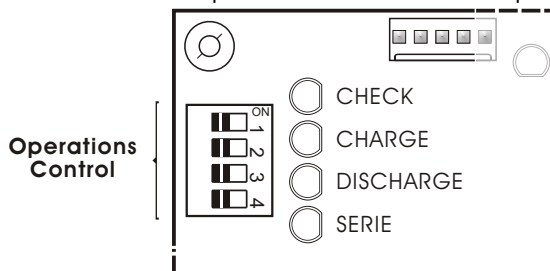

Each time you insert a card on the reader, the module will check its status, if it is authorized or not. If it is not authorized, the red OFF Led will shortly light on and you heard an acoustic signal to indicate that the access is denied. At the opposite, if the card is authorized, the circuit will connect the relay activating the output. The green Led ON will light on and the acoustic signal will be different.

The connection time of the relay (when the access is authorized) could be adjusted between 1 and 4 sec. Place switches of "Relay Timing" according to your needs.

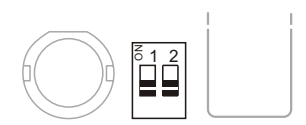

Relay Timing (1 sec).



Relay Timing (2 sec).

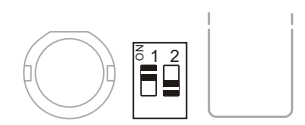

Relay Timing (3 sec).



Relay Timing (4 sec).

OPERATING.

ACCEPTATION CONTROL. The DA-01 module includes an acceptance control or key allowing to deny any operation with operations control mode and to avoid a wrong use of Authorization, Deny, Check or Serial functions from unauthorised people. You only have to place the INT-1 Switch in OFF position and the access to these functions will be blocked. To activate again these functions, you only have to place the INT-1 switch in ON position.

one, you have to use both terminals of the Jumper or piece indicated as JP1 to connect it. Do never desold or remove the original button from the circuit. To avoid to have a wrong operating,

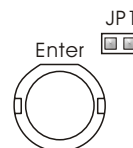

ACCESS CONTROL TILL 1999 MAGNETIC CARDS.

GENERAL WIRING MAP.

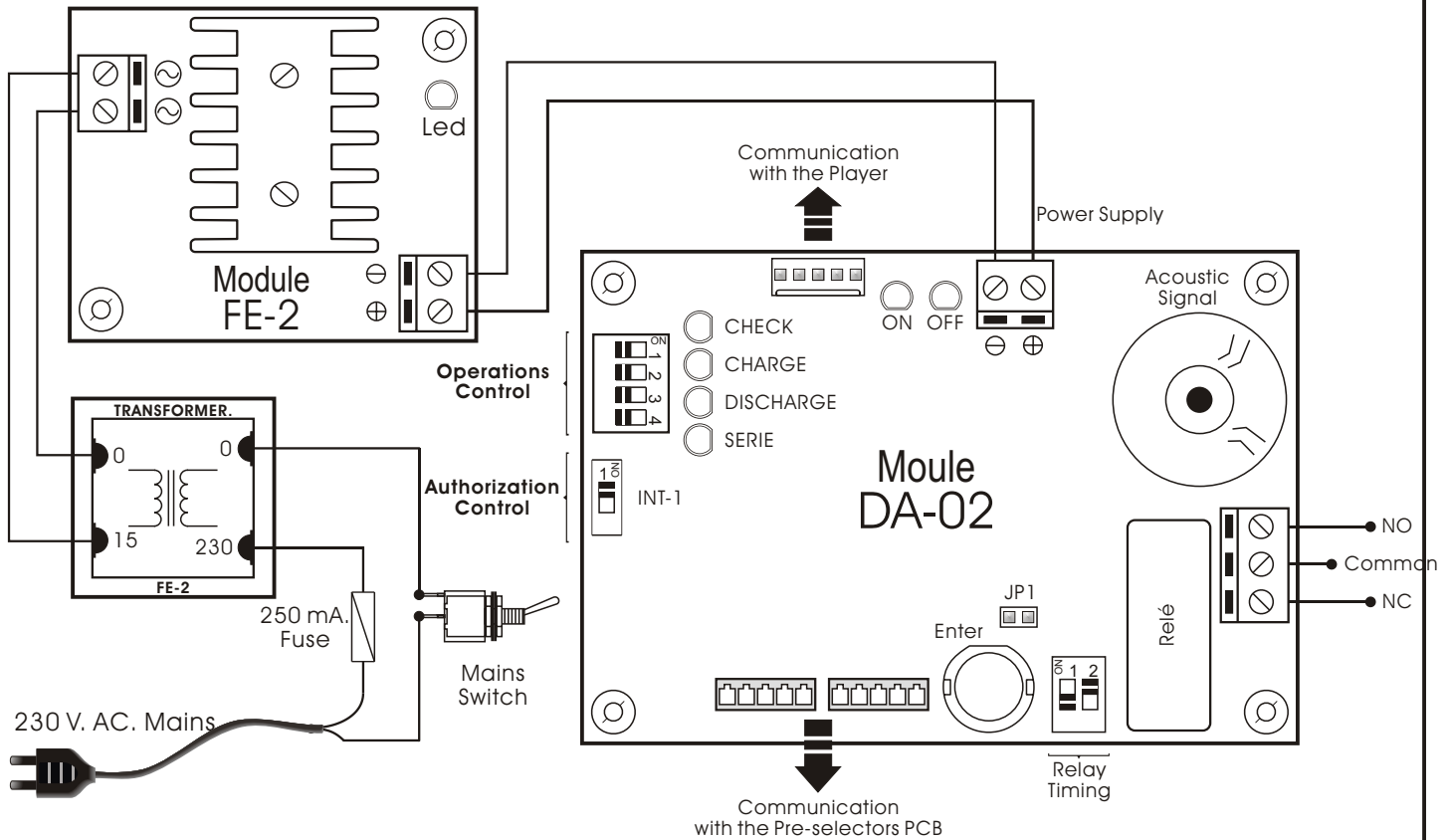

FRONTAL VIEW

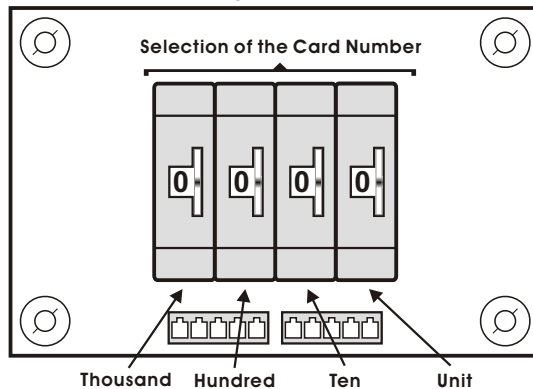

INSTALLATION AND USE.

Connection between PCB. Do not remove, amplify or modify interconnection cables of the module, like communication between main PBC and pre-selectors PCB, or between player and main PCB. If you do not respect these instructions, the module could be damaged and corresponding warranty will be canceled.

Installation. To instal the module, this one had to be insulated from other apparatus which could emit interferences. If it is necessary, you have to use a mains filter and instal it at the required place.



OUTPUT CONNECTION - LOAD.

OUTPUT CONNECTION. The DA-02 output is controlled by a relay, and accept any device up to 4 A. The relay have three output terminals: The normally open quiescent (NO), the normally closed quiescent (NC) and the common. This mechanism operate like a switch with two terminals NO and Common. For the inverse function you have to use the NC and Common. In the drawing hereafter, you could see a typical connection with a 12 V D.C and 230 V A.C devices.

12 V. DC CONNECTION

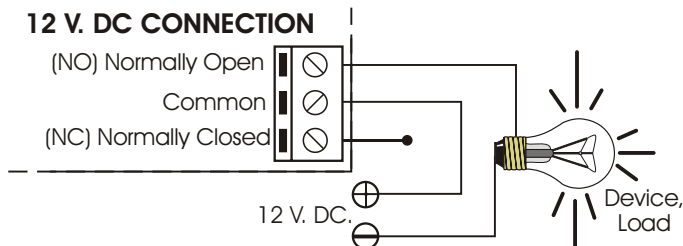

230 V. AC CONNECTION

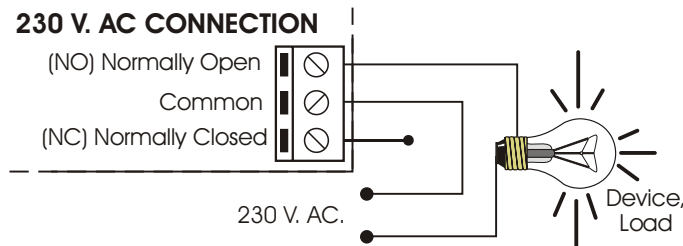

INFORMATION ABOUT THE OUTPUT. During the operating mode and according to its load, it could happen a fluctuation or an incorrect working of the output. In such case, you have to install an anti-spark circuit between both contacts of the used relay, as it is indicated on the schedule.

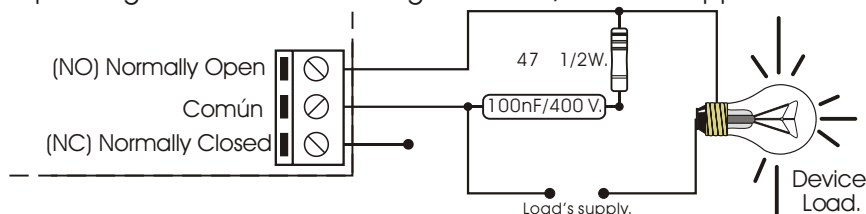

HOW TO PERSONALIZE CARDS.

Cards includes an adhesive protection to allow to put your personal data if you wish :

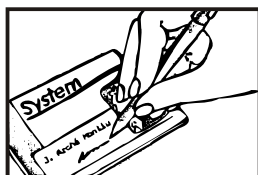

1. Put the label, card or picture with your data, or write them

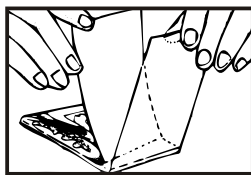

2. Withdraw the adhesive sheet.

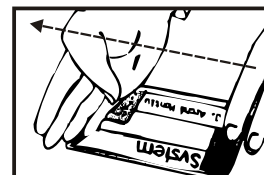

3. Install it and press it with your fingers to make more easy its

The DA-02 module is supplied with 5 cards, the rest up to 1999 (if you need them) have to be required. Then, if you need other cards, you have to communicate to your distributor the code that you already have with your 5 first cards.

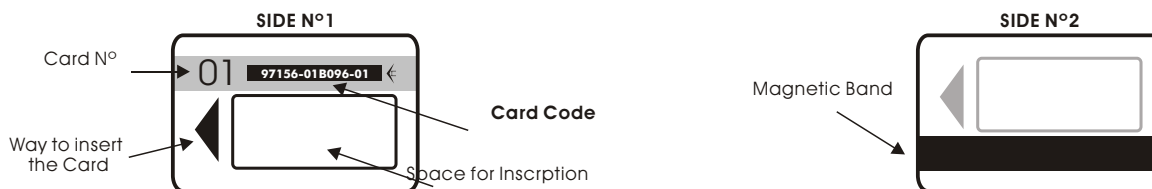

TECHNICAL CONSULTATIONS.

If you have any doubt, you could contact your wholesaler or our Technical Department.
- Via E-Mail, sat@cebek.com | by mail P.O Box 23455 - 08080 BARCELONA - SPAIN.
- **Keep the invoice of this module.** For any repair, the corresponding invoice had to be added. If the invoice is

**MORE 300
MODULES.**

All the module's CEBEK have **3 years of total warranty** in thechnical repairing, and spares from the date of buy.

CEBEK is trade make of FADISEL S.L. more than 300 module's are avabile in stock for any purpose **request our CATALOGUE**, or visit our Web.
[Http://www.cebek.com](http://www.cebek.com)

WARRANTY

**3
YEARS**