



cebek[®]

REMOTE RECEIVER RF 12/24VDC 2 relay outputs TL-601

CHARACTERISTICS

Power: DC 12/24V
Maximum consumption: 130 mA
Relays switched circuit: 250V AC - 3 A maximum per relay
Reset input: by contact closure
Antenna: Included
Frequency: 433.92 Mhz
On indicator relay: LED 5 mm.
Relay operation mode: Configurable in single, double, and timer from 0.1 to 132 sec
Response time (delay order issuer relay response) 0.2 sec.
Compatibility: RF Transmitters Group 3, TL-300 / TL-301
Weight: 420 grams ..
Dimensions: 98.75 x 72 x 30 mm.
Working temperature: - 10 ° C to + 45 ° C
Regulatory: EMC 89/336/EEC and 93/68/EEC and amendments 23/31/CEE with ETS legislation 300-200
Electrical insulation : IP55

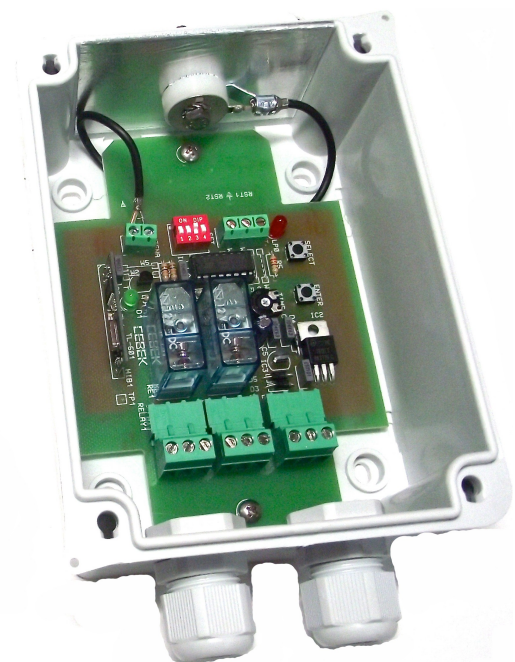

INSTALLATION

Power must be on the entry "Power" directly to 12 / 24V DC.
It uses a stabilized linear power supply or battery.

power Connection

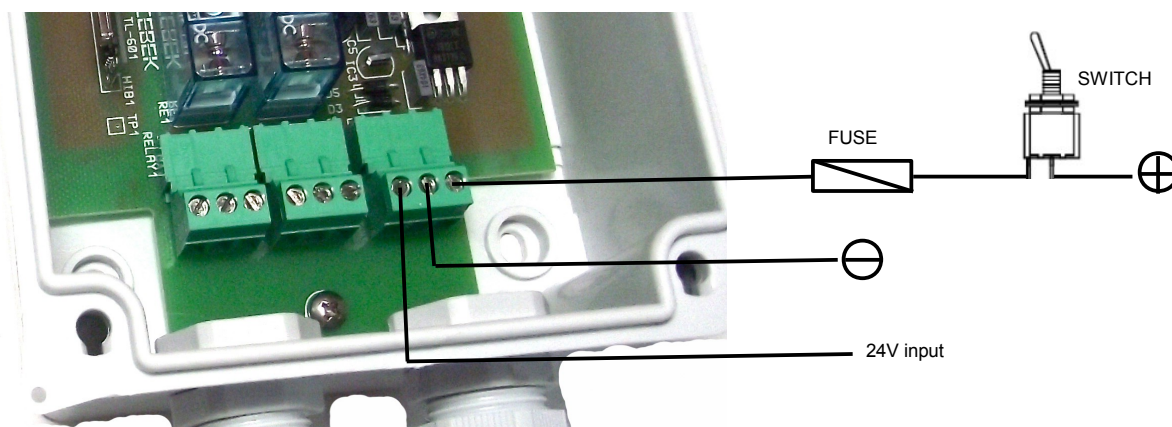

NOTE: To comply with CE installed fuse and switch

PROGRAMMING.

The receiver can not be controlled directly without prior programming.

Once completed, it will be stored even without power, and is not removed to be replaced with a new one.

IMPORTANT. Install receiver antenna before programming

Pair with sending unit.

Each receiver supports up to 5 Cebek emitting RF group 3, which exclusively paired with them, avoiding any other remote activation from outside transmitter.

By default, the receiver is supplied blank without associated codes, so it can be programmed to interact with particular issuer. In the match with a relay transmitter button is also stored in the combination set dipoles, and is assigned to relay the appropriate operating mode, you can select between three different types: bistable, monostable or timed.

Programming is accomplished simply by performing the following steps:

1. Installation of the antenna and the receiver. Without connecting the load.
2. Dip Set the combination of which determines the type of operation that will take the relay (Fig. 3).
3. It starts receiver programming button briefly pressing "Enter". The red LED will light.
4. With the receiver in standby, the button must be pressed only the issuer to which you want to associate. The transmitter button must remain closed until the LED LPO perform three cycles of flash and fixed (process to read and correctly identify the sender button). This operation may take a few seconds.
5. The programming is ratified, briefly pressing the button again on "Enter" on the receiver or waiting 20 seconds. The red LED will turn off.

Next relay. To program the next relay, you must re-start the programming process again from step 1. However, when the LED lights of the first relay point, press briefly Select, the new relay will be selected from the corresponding LED to light up. From that point you should just completed the rest of the process.

Memory is FIFO, so pairing from 5 issuers, occupy the next scheduled destination memory is the first, another memory for initially replace the second and so on.

Setting a timed operation, the relay also stores the position of the potentiometer "Time". The entire circuit of the potentiometer is set between the margins of the scale selected in the Dip. The specific portion which potentiometer will establish the exact time of timing

	SW1	SW2	SW3	SW4
monostable →	Off	Off	Off	Off
timer (0,1 a 12,9 sec.) →	Off	Off	Off	On
timer (10 a 35,5 sec.) →	Off	Off	On	Off
timer (30 a 55,5 sec.) →	Off	Off	On	On
timer (1 a 2,2 min.) →	Off	On	Off	Off
bistable →	On	On	On	On

Figure 3 Configuration Dip
* Response relay operation

OPERATION.

When idle, the receiver relay is inactive, keeping the connection between contact "Common" and "Nc." When the relay is activated switches connecting internally contacts to join the "Common", "No" , allowing the passage of current to the load.

Each relay will respond independently to a bistable operation, or timed shot as was scheduled.

Reset. When pressing Reset, the relay will go inactive, abandoning any previous order. As long operated reset, the relay will not respond to any order of the issuer.

In bistable. The issuer assumes button operation of a switch, activating or deactivating the relay alternately in each press. Until there is a new push, the state in which the relay is to remain flat.

In One Shot. As long as the issuer closed the button, the relay will be activated, deactivated when the button is released.

Timed. The relay is activated when you close the button of the issuer. The timing, however, will start when the button is released, at which point the start and after which the relay is deactivated

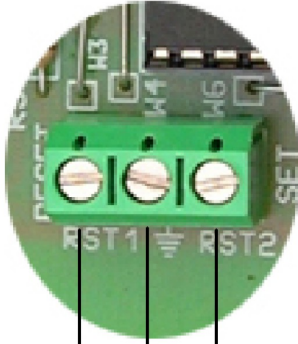

RESET ACTIVATION

When "RST1" or "RST2", the corresponding relay automatically switches to idle state, regardless of the order that was previously running. The length of the cable used for each reset input should be as short as possible.



Relay connection

The relay connection must not be seen as an output, provides no tension. Electrically isolated from the rest of the circuit, its function is to open or close its contacts to allow or interrupt the passage of an electrical signal, as would a common switch on a light bulb.

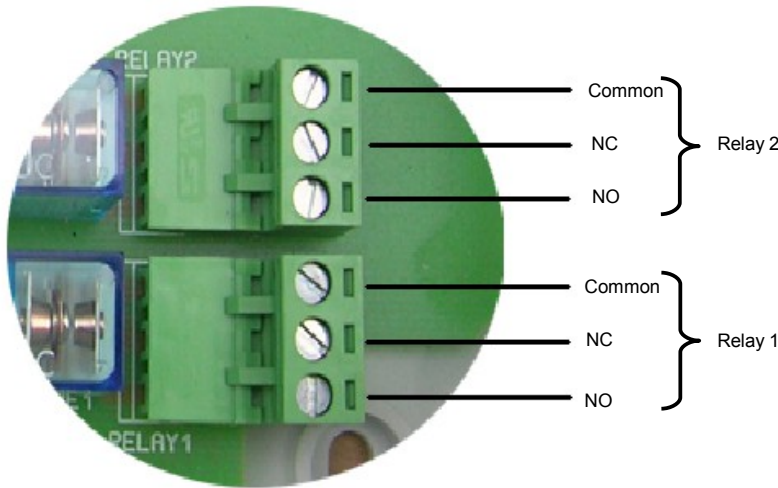

Relay connection. Load control.

The relay connection must not be seen as an output, provides no tension. Electrically isolated from the rest of the circuit, its function is to open or close its contacts to allow or interrupt the passage of an electrical signal, as would a common switch on a light bulb. The relay has three terminals: the common, normally open at rest (NO) and normally closed quiescent (NC). One of the two feed wires of the load should be connected directly to the load, the other must be introduced through the relay contacts, typically between the Common and NO, as specified in the scheme of Fig. 1, so that the relay internally cut or allow the flow of electric charge.

DC load connection

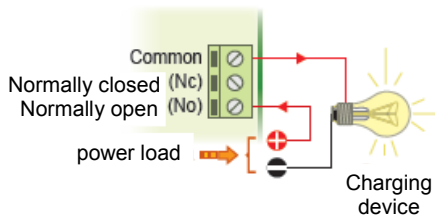

Load connection AC

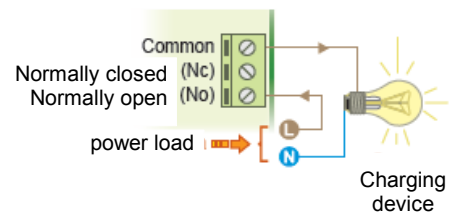

Especially with inductive loads, a relay output can produce a fluctuation, intermittent, apportionment, or an incorrect operation. If this happens, you will need an anti-spark circuit between the two relay contacts used in this connection, that ensure absorption peak current that causes the above problem. Note Fig. 2. Si load circuit connected to the relay is powered at 230 V. 100nF/400 apply a condenser V. and a resistance of 47 ohms $\frac{1}{2}$ W. If you have a X2 type capacitor 100nF (most effective), resistance is not required. In applications where the load is fed at 12 or 24 V. DC only contemplate the condenser installation without resistance. Should be tested with values between 10 nF and 47 nF until the fluctuation disappears.

**Fig 2 filter anti-relay fluctuations
230V AC load from 50W**

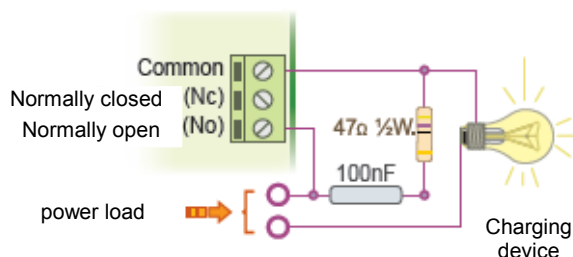

INFORMATION concerning the environmental protection

When this product is no longer in use, can not be placed with normal household waste, you must take it to a collection point for the recycling of electrical and electronic equipment. A symbol on the product, the instruction manual or the package indicates. The materials are recyclable as marked. If you practice the reuse, recycling or other use of old appliances is making an important contribution to environmental protection. Please consult your municipality what the point of proper disposal or landfill nearest your home.



CONSIDERATIONS / WARRANTY

This kit is intended for use by professionals, or users with sufficient technical or knowledge, allowing them to develop their own projects or desired applications. If used for educational use is encouraged and assembly use under the supervision of teachers. Cebek products have 3 year warranty from date of purchase. Excluded mounting or mishandling. We reserve the right to make technical alterations. We assume no responsibility for printing errors. The technical documentation of this product responds to a transcript provided by the manufacturer.



Cebek [®] is a registered trademark of the Fadisel group