

EDUCATIONAL MODULES

For LEARNING and to PRACTISE the ELECTRONICS

www.cebek.com

EDU-008. The Led Display.

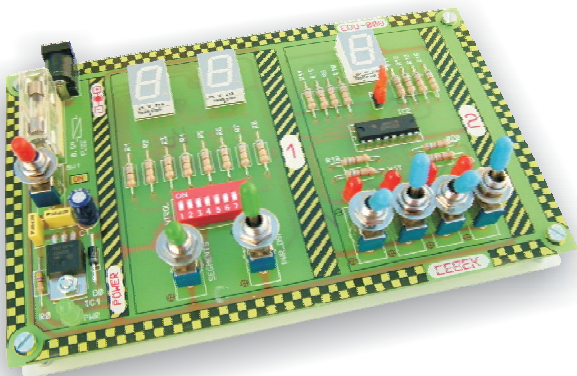

- The EDU-008 module is composed by 4 practices allowing to verify and to compare principles of the Led Display, the common cathode or anode. Thanks to these two blocks which divide the module, you only require a power supply, a multimeter to work and to make different practices.

The module includes: Description and practice of the 7 Segment BCD decoder, regarding the CD4511 integrated circuit.

- Practice 1.** Internal division of the display. Supply.
- Practice 2.** Limiter resistors. Direct voltage.
- Practice 3.** Individual control of segments.
- Practice 4.** BCD Control and 7 segments decoder.

EDU-008

EDU-008. The Led display.

Warranty and Do not forget.

Cebek educational modules included in the EDU serial offer several practices to analyse, experiment and to learn basic knowledge on the studied theme. Nevertheless, their function is not to make a mini-class on each theme, but to complete and to be used as basis, as well as to allow to experiment on the theoretical theme evocated by the teacher. For this reason, we suggest you to use modules form the EDU serial under the supervision and the direction of a teacher.

Cebek doesn't offer a consulting service as concern the theoretical or the operating principles concerning the theme deal with the module. It only offers a technical assistance regarding questions and problems coming from the circuit's internal operating mode.

All Cebek modules included in the EDU serial have a warranty of 3 years as concerning components and labour man. All damages provoked by external causes (from the circuit), as well as wrong connections or installations or due to an operating mode no indicated into the module's documentation won't be covered by the warranty. More over, all wrong or incorrect handling won't be excluded from the warranty. For any claim, you have to present the corresponding invoice.

To contact our technical department, you can send a message to sat@cebek.com, or a fax :Nº+34.93.432.29.95 or a mail to the following address: CEBEK, c/Quetzal, 17-21, 08014 Barcelona (SPAIN).



EDU-008



Rules and Identification of the EDU serial elements.

To make easier the identification and for a single rule as concern different practices and educational Cebek modules, all common elements will answer to colour code and to a shape.

Test Point. (TP).

It allows to connect oscilloscope's or multimeter extremities to read parameters relating to the practice. According to its colour, it will indicate that the Test Point (TP) is connected to the positive or to the negative of the circuit, as well as reads concerning current, voltage, load, etc....



TP. + circuit
Red



TP. - circuit
Black



TP. Tension
Yellow



TP. Courant
Blue



TP Without current or TP AC.
White

Commutator / Switch.

According to the colour of the switch, you can control the voltage, the current



Power supply
Red



Current
Blue



Voltage
Yellow



Logical
Green

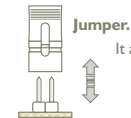

Jumper.

It allows to close or open a signal or an electrical circuit

EDU-008. The Led Display.

Before to start...

Before to start a practice, it is very important to carefully read its instruction manual as well as corresponding indications.

You have to do correctly connections in indicated contact points, otherwise measures depending on these connections will be confuses or wrong.

Do not make connections not indicated in the instruction manual to avoid to damage the circuit.

If the Led of the power supply "PWR" doesn't light on or if its function suddenly stops, you have to quickly disconnect the power supply for the device and check there is any short-circuit as well as the fuse's status.

Even if described practices can be done following instruction manual, we recommend you to use it under the supervision of a teacher who can advise and bring you a support (an help) concerning described concepts.

In the circuit, each practice will be delimited by a rectangle with the corresponding number. One or several experiment(s) can be reported and referenced to this practice.

Module's power supply.

The module has to be supplied at 12 V AC. You have to use a laboratory stabilised power supply like our Cebek FE-113.

The circuit's feed is done through the male connector inserted on the board, **do not inject signal on any other terminal placed on the circuit.** Once supplied, the circuit offers necessary voltages to make experiments with each practice. To connect the power supply, the module includes a cable wit a male connector at one extremity and wires at the other extremity.

Connect all terminals to the transformer output. Finally, you could insert it into the module.

Note: The circuit fuse is 500 mA.

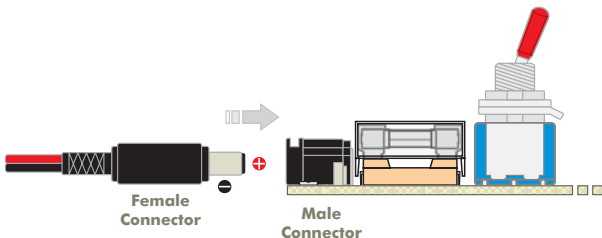

Required Material.

You won't need any additional material or components to experiment with this module. You only need basis measure instruments to obtain and to compare obtained values from this practice. For this module, you will need multimeter with its voltmeter function.

Bibliography.

- Electronics practice 3. (Digital Systems) - E. McGraw-Hill. Authors: A. Rodríguez, Manuel Rosillo, Rafael Caraballo...
- with google: Displays - Vishay - 7-Segment LED displays | fairchildsemi

EDU-008. The Led display.

Practice 1. Internal division of the display. Supply.

The Led display is a group of leds, injected in a waterproof format. There are different types of Leds that you can use to represent forms, letters and numbers. Each part of the letter or number is named segment, and according to the display's dimension, it can contains one or several diodes connected in serial. You can visualize a determined number or letter according to segments' state, if they are or not supplied.

In order to avoid a pin excess, and therefore to optimize the electronic control from multiplexed circuit, internally all segments have a led extremity connected between them, and according to one of both is the common, we can determinate two types: Display with common anode and displays with common cathode, the internal drawing of these one is represented as following:

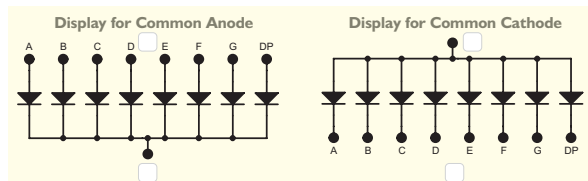

The practice N°1 allows to shows different power supplies and the segments control according to the display type; common cathode or anode. The goal of this practice is to identify the power supply polarisation of the display as well as the control input one for each segment regarding the common cathode or anode configuration.

In this practice, all micro switches of the CONTROL DIP have firstly to be placed in "ON" position. Each segment of the AND display (common anode) is connected to its corresponding segment on the CAT displays (common cathode), therefore their polarisation will be the same and it is controlled by the SEGMENT switch. This one will inject a 9V positive or 0V negative signal. At the same time, commons of both displays are connected between them, receiving the positive or the negative according to the PWR-DSP switch's position. The goal is to find the polarity required by each display configuration and to note it in the previous table.

Practice 2. Limiter resistors, direct voltage.

Internally, each segment is a led or a group of leds assembled in serial, then they have the same physical behaviour. Therefore, there are a direct and a maximal current admitted by the segment and once over passed these currents, you have to use a limiter resistor to control them.

For displays in this practice, the manufacturer indicates a minimum direct voltage 2V and a maximal one 3V (named Forward Voltage) per segment, and he also recommends a maximum current 15mA (named Forward Current). Therefore, when the control voltage for display will be superior to the direct voltage, you have to place a limiter resistor (R_{seg}) in each segment.

$$R_{seg} = \frac{V_{dc} - V_{Fseg}}{I_{Fseg}}$$

$$V_{dc} = V. \text{ Supply} \quad V_{Fseg} = V. \text{ Segment} \\ I_{Fseg} = I. \text{ Segment} \quad R_{seg} = R. \text{ Segment.}$$

EDU-008. The Led Display.

Practice 2. Limiter resistors, direct voltage, (2nd part).

Its formula will be the difference between the supply voltage of displays (V_{cc}) less the voltage fall of each segment (V_{Fseg}), divided by the segment current (I_{Fseg}).

Using once again value of the practice, $V_{cc}=9V$, $V_{Fseg}=2V$ and $I_{Fseg}=15mA$, and applying the formula, you will obtain the following result: $4666,6\ \Omega$.

Therefore, in the practice, we have used $680\ \Omega$ resistors in order to prolong the display's life.

Practice 3. Individual control for segments.

The 7 segment display, as its name indicates, is composed by 7 areas and one more for the point (DP), being able to independently light on. In such case their distribution, which represents the number eight lights off, allows the characteristic composition for numbers from 0 to 9 as well as for several letters.

Other displays, with different forms, can generate letters and symbols, using a segments matrix or points, also named pixels. A character being the numbers, letters and symbols group which can be represented by a display.

This practice consists of select and identifies necessary segments to generate indicated characters.

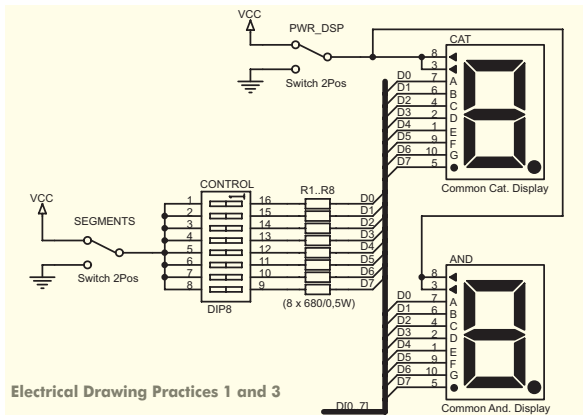

Electrical Drawing Practices 1 and 3

Before to start this practice, all CONTROL DIP micro switches have to be placed in "OFF" position. Then, you have to select one of both displays from the Bloc N°1 and to correctly polarize it (see how to proceed in practice N°1).

Each micro switch from the DIP will control the lighting of different display's segments. Thanks to a small screwdriver, or the tip of a pencil, you have to place in "ON" position all necessary segment to obtain the character represented in the following drawing, to finally compose the complete card of Display's segments.

EDU-008. The Led Display.

Practice 3. Individual control for segments, (2nd part).



Used Segments:

Seg. A Seg. B
 Seg. C Seg. D
 Seg. E Seg. F
 Seg. G DP.



Used Segments:

Seg. A Seg. B
 Seg. C Seg. D
 Seg. E Seg. F
 Seg. G DP.



Used Segments:

Seg. A Seg. B
 Seg. C Seg. D
 Seg. E Seg. F
 Seg. G DP.



Used Segments:

Seg. A Seg. B
 Seg. C Seg. D
 Seg. E Seg. F
 Seg. G DP.



Used Segments:

Seg. A Seg. B
 Seg. C Seg. D
 Seg. E Seg. F
 Seg. G DP.



Used Segments:

Seg. A Seg. B
 Seg. C Seg. D
 Seg. E Seg. F
 Seg. G DP.



Used Segments:

Seg. A Seg. B
 Seg. C Seg. D
 Seg. E Seg. F
 Seg. G DP.



Used Segments:

Seg. A Seg. B
 Seg. C Seg. D
 Seg. E Seg. F
 Seg. G DP.



Used Segments:

Seg. A Seg. B
 Seg. C Seg. D
 Seg. E Seg. F
 Seg. G DP.



Used Segments:

Seg. A Seg. B
 Seg. C Seg. D
 Seg. E Seg. F
 Seg. G DP.



Used Segments:

Seg. A Seg. B
 Seg. C Seg. D
 Seg. E Seg. F
 Seg. G DP.



Used Segments:

Seg. A Seg. B
 Seg. C Seg. D
 Seg. E Seg. F
 Seg. G DP.

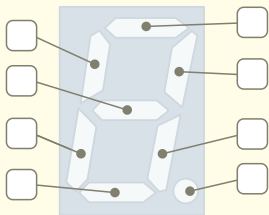

EDU-008

EDU-008. The Led Display.

Practice 4. BCD Control and 7 segments decoder.

On the display, the visualisation of a number thanks to the individual excitation of each segment will require 7 data lines as well as the electronic part which generate the combination of corresponding segments for each number.

In the practice N°4, it is described the 7 Segments BCD decoder, which allows to control a display with only 4 data lines and binary code. The goal of this practice is to elaborate a true table with decoder output values, where you have to indicate the binary code with the corresponding number visualised on the display.

EDU-008

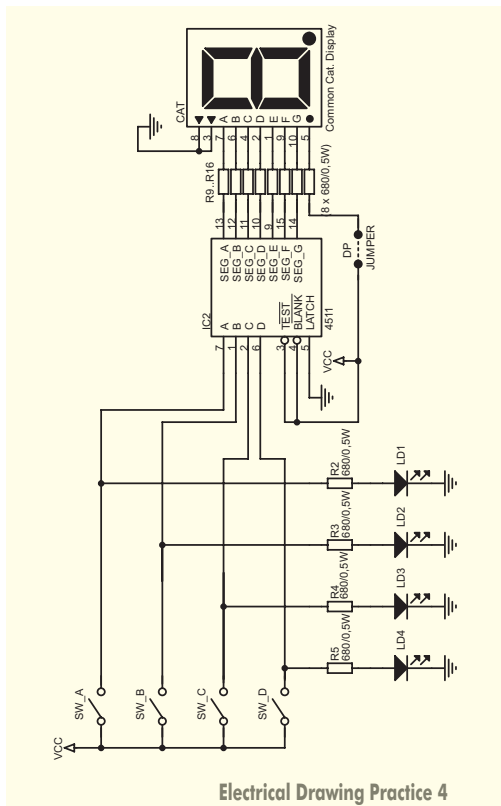

EDU-008. The Led Display.

Practice 4. BCD Control and 7 segments decoder, (2nd part).

The CD4511 module (often named 4511) is a CMOS converter with 7 segments BCD code. This integrated circuit includes 4 inputs for the binary number and 7 outputs that you can directly connect to segments.

Its function consists of recognize the binary number and to activate segments outputs necessary to allow to the display to visualise the corresponding decimal number.

There are other 7 segments BCD decoders which accept a binary code from 0 to 16, allowing other special characters after the 9. Nevertheless, the 4511 module maintains its display without indication from 10 to 16.

BCD numbers corresponding to the true table are configured through switches from SW-A to SA-D. According to their position, they will inject on the decoder a logical "0" (negative), or a logical "1" (positive), composing the BCD number. You have to know that the bit with the lower value (LSB) corresponds to the SW-A switch and the high value (MSB) corresponds to the switch SW-D.

When one of the 4 input bits is placed on the high level, indicated by the positive symbol close to the switch, the corresponding associated led lights on. This led will remain lighted of when the input is on the low level (indicated by the negative symbol). The logical "1", or high level is equal to Vcc (9V). The logical "0", or low level, is equal to 0V. As the numbers 0 to 9 are introduced in BCD, you can note that the component activates exactly the same segment, already defined in the practice N°3, supplying a negative to active segments and a positive to segments lights of, as it was indicated on the practice n°3.

Note: The decimal point is not controlled by a decoder, but directly of the negative through the DP jumper.

| Code BCD | | | | CD4511 Decoder Segment/Output: | | | | | | | Display |
|----------|---|---|---|--------------------------------|--------------------|--------------------|--------------------|-------------------|--------------------|--------------------|---------|
| D | C | B | A | seg. A (pin 13) | seg. B (pin 12) | seg. C (pin 11) | seg. D (pin 10) | seg. E (pin 9) | seg. F (pin 15) | seg. G (pin 14) | |
| 0 | 0 | 0 | 0 | | | | | | | | 0 |
| 0 | 0 | 0 | 1 | | | | | | | | 1 |
| 0 | 0 | 1 | 0 | | | | | | | | 2 |
| 0 | 0 | 1 | 1 | | | | | | | | 3 |
| 0 | 1 | 0 | 0 | | | | | | | | 4 |
| 0 | 1 | 0 | 1 | | | | | | | | 5 |
| 0 | 1 | 1 | 0 | | | | | | | | 6 |
| 0 | 1 | 1 | 1 | | | | | | | | 7 |
| 1 | 0 | 0 | 0 | | | | | | | | 8 |
| 1 | 0 | 0 | 1 | | | | | | | | 9 |
| 1 | 0 | 1 | 0 | | | | | | | | off |