



cebek[®]



2 CHANNEL BIESTABLE RECEIVER VIA CABLE TL-63

TECHNICAL CHARACTERISTICS

Voltage	Through the booster.
Minimum Consumption	20 mA.
Maximum Consumption	120 mA.
Max Load per Output	3 A.
Protection against polarity inversion, (P.I.P.)	Yes.
Dimensions	106 X 62 X 30 mm.

The TL-63 will decode codes sent from the emitter, recognizing channels and connecting or disconnecting consequently outputs. It admits TL-50 and TL-51 transmitters .
It includes micro switches to select the code, indicator leds, and connection terminals.

INSTALLATION

Note. Before to start the installation, it is very important to carefully read the TL-55's (booster) instruction manual, then you could use this module.

POWER SUPPLY AND DATA ENTRY. The TL-63 supply doesn't require an external power supply. The module will be fed directly from the Receivers Communication Cable, provided by the booster, which also supply control data. For this connection do not use an independent cable from each receiver to the booster, but an union cable between your TL-61 and the Mmin Communication cable with Receivers. See Fig 1. .

Fig1. Connection between Receiver and Transmitter

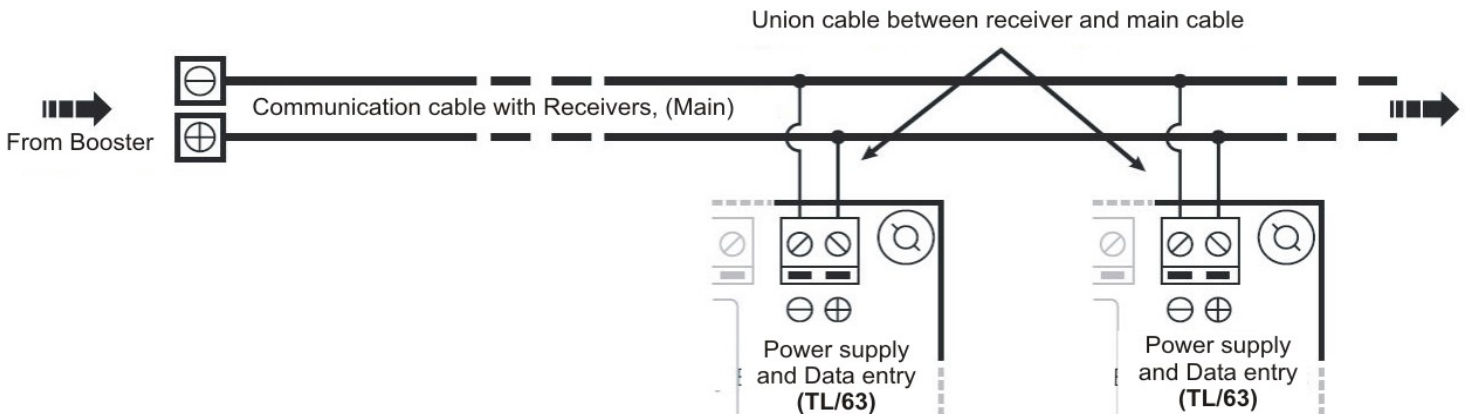

Therefore, connect the positive and the negative cables of the power supply input and Data of the TL-61 to the respective positive and negative Communication Cable with Receivers. Before to follow the installation, make sure that the assembly has been correctly done.

OUTPUT CONNECTION. LOAD. The TL-63 outputs are controlled by a relay, and accepts any device up to 3 A. The relay is not a component supplying voltage but its function is limited to accept or deny the voltage passage like a standard switch. For this reason, you have to supply the load through this component. The relay has three output terminals: The normally open quiescent (NO), the normally closed quiescent (NC) and the common. Install it between the Common and the NO in accordance with the schedule “Output Connection. Load”. For the inverse function you have to place the load between the NC and Common.

● **12 V DC Connection.**

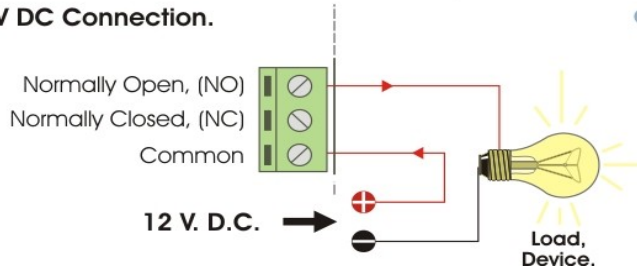

● **230 V AC Connection**

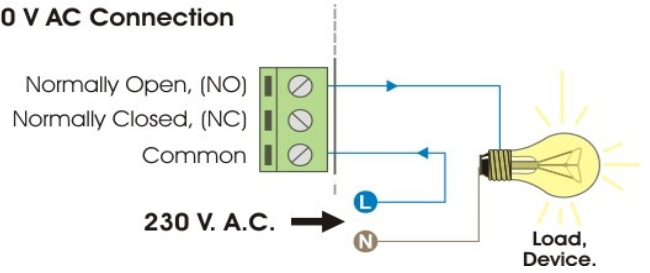

INFORMATION ABOUT THE OUTPUT. During the circuit operating mode and according to its load, it could happen a fluctuation or an incorrect working of the output. In such case, you have to install an anti-spark circuit between both contacts of the used relay, as it is indicated on the drawing.

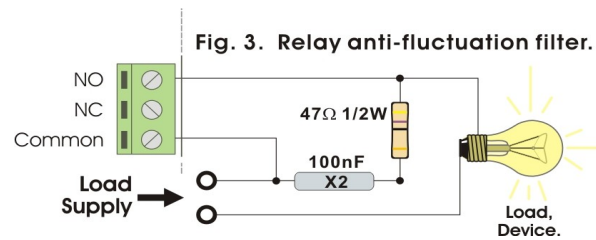

TO CONFIGURE THE 2 CHANNELS

SHIPMENT OF DATA. When you select a decimal number on the transmitter and send an order, the channel on with this assigned number will recognize and execute it. Therefore, each channel or output must have a different code that differentiates it from the others. Otherwise, if different channels have the same code, all these channels would be connected at the same time when the transmitter will emit an order on this code.

Each output or channel has its own micro switches battery to allow you to configure the code or identification number. On the TL-61, the DIP1 micro switches battery will control the channel N°1, and DIP2 battery will control channel N°2. The configuration and introduction of this code will be done differently according to the used TL-50 or TL-51 transmitter. Read the corresponding paragraph.

OPERATING WITH EMITTER TL-51. To use the TL-51 as transmitter in you Via Cables Cebek system, you have to configure micro switches of the receiver as it is described hereafter:
 Select on each channel a decimal number between 1 and 255. When you indicate it on the corresponding micro switches battery, you must do it in binary.
 The conversion from a decimal number to a binary one or vice versa can be done with a scientific calculator. See instructions of your calculator regarding this matter. However, you have a key with DEC (decimal) and BIN (Binary) abbreviation. In order to do the conversion from decimal to binary, you have to firstly select the DEC option in the calculator, then introduces the decimal number. Finally select the option BIN and the calculator will do the conversion, displaying the corresponding binary number. This number, composed by zero and one will be the number that you have to assign to the wished channel.
 Each micro switches battery is composed by 8 switches that can be positioned in ON or OFF. If you select the ON position, this one will be configured as 1. If you select OFF position, it will be configured as 0. Then you could indicate on the battery the required binary number.
 Once you have this number, you have to indicate it on the corresponding battery. To do it, you have to place all switches in ON position (1), or in OFF (0) according to the selected number. Switch 1 will be the bit with smaller weight (LSB), whereas switch 8 is the major weight (MSB). Then, you have to introduce the binary number in the opposite way regarding the way you write it on a paper.

Fig.2 Switches value according to their position



EXAMPLE. To indicate the number 87 on the channel N°1 and number 3 on the channel N°2. Firstly, you have to convert both decimal numbers into binary numbers. The equivalent binary for the number 87 is 1010111, and the equivalent of the number 3 is 11. After the conversion, start introducing the code 1010111, (corresponding to the number 87) in DIP1 battery. Remember that units will correspond with switch 1; tens with switch 2; hundreds with switch 3, etc.... Therefore you have to configure the number as it is described in fig 3. Switches not used, as in this case the 8, must to remain to 0 (In OFF position).

Fig.3 To insert the number 87, binary code 1010111, on the DIP1

- 1.- 87 Decimal = 1010111 binary
- 2.- To insert the binary number taking in account LSB and MSB bit

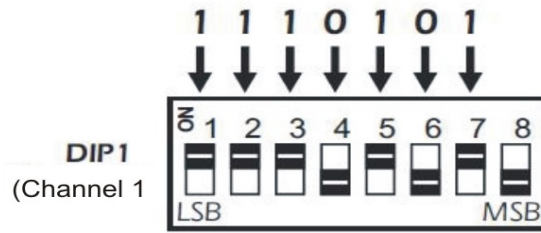

After the DIP1, you have to configure the DIP2. Repeat the previous process, introducing the code 11 (corresponding to the number 3). Like in the DP1 battery, switches not used, in this case the 3 and 8, must to remain to 0 (In OFF position).

Fig.4 To insert the number 3, binary code 11, on the DIP2

- 1.- 87 Decimal = 11 binary
- 2.- To insert the binary number taking in account LSB and MSB bit

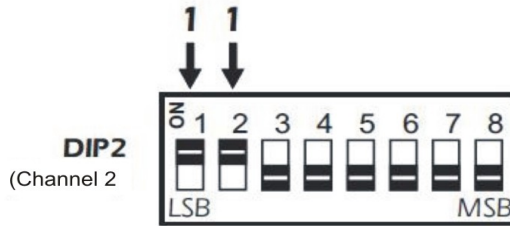

OPERATING WITH L-50 TRANSMITTER.

If in you Via Cable Cebek system you have installed as transmitter the TL-50, you could only control 99 different channels, configuring micro switches in each channel of the receiver, as it is described hereafter:

8 switches that can be placed in ON or OFF position compose each battery. The first fours will allow the units adjustment, whereas the last fours allowing the tens adjustment. In order to introduce a number from 0 to 9, you have to do it in binary mode, for units and tens. See fig 5, Puts switches in ON or OFF positions according to the number that you wish to introduce.

Do not indicate any other combination except the determined one in this drawing, otherwise the system will not operate correctly.

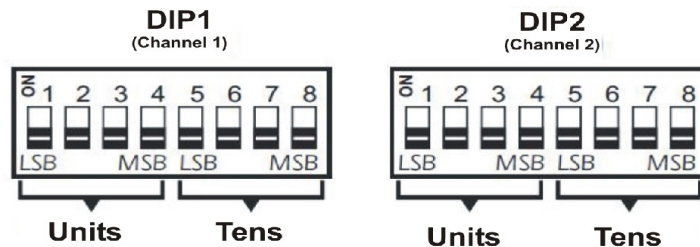

Fig.5 To configure switches according to the inserted number

Switches	1	2	3	4	5	6	7	8
Number 0	Off	Off	Off	Off	Off	Off	Off	Off
Number 1	On	Off	Off	Off	On	Off	Off	Off
Number 2	Off	On	Off	Off	Off	On	Off	Off
Number 3	On	On	Off	Off	On	On	Off	Off
Number 4	Off	Off	On	Off	Off	Off	On	Off
Number 5	On	Off	On	Off	On	Off	On	Off
Number 6	Off	On	On	Off	Off	On	On	Off
Number 7	On	On	On	Off	On	On	On	Off
Number 8	Off	Off	Off	On	Off	Off	Off	On
Number 9	On	Off	Off	On	On	Off	Off	On

For a better understanding, the following example shows how to assign the number 7 to the channel N°1 and the number 83 to the channel N°2.

Start inserting the number of the channel N°1. On the corresponding DIP1 battery, insert the units. In this case you have to select on switches 1 to 4 the binary combination corresponding to the number 7. After units you have to introduce tens. In order to indicate a 0 for switches 5 to 8 you have to do the corresponding combination. See fig 5.

Once the channel N°1 configured, on the DIP2 battery of the channel N°2, for switches 1 to 4 you have to do the combination corresponding to the number 3 (Units). Then, for switches 5 to 6 (Tens), you have to select the combination corresponding to the number 8. Finally, see fig 6 where you can find the final result.

Fig.6 How to configure the channel 1 with the number 7, and the channel 2 with the number 83



OPERATING MODE. Once the installation done, and configured the TL-63 with its identification codes for each channel, the module will be awaiting order from station.

Avoiding other codes, when each channel receives its code for the first time, it will activate the output, remaining connected until the transmitter sends again its code; and at this moment it will be disconnected. Each time a channel will receive the identification code, it will modify the output status, activating it if it were disconnected and deactivating it if it were connected.

If you don't indicate any code to an output or channel, leaving all battery switches in 0 (OFF position), the output will be automatically activated when the transmitter doesn't send any order. In order to avoid this operating mode, you have to configure the output with a code

GENERAL WIRING MAP

